

SURFACE SYSTEMS (MAP)

SYSTEM 20

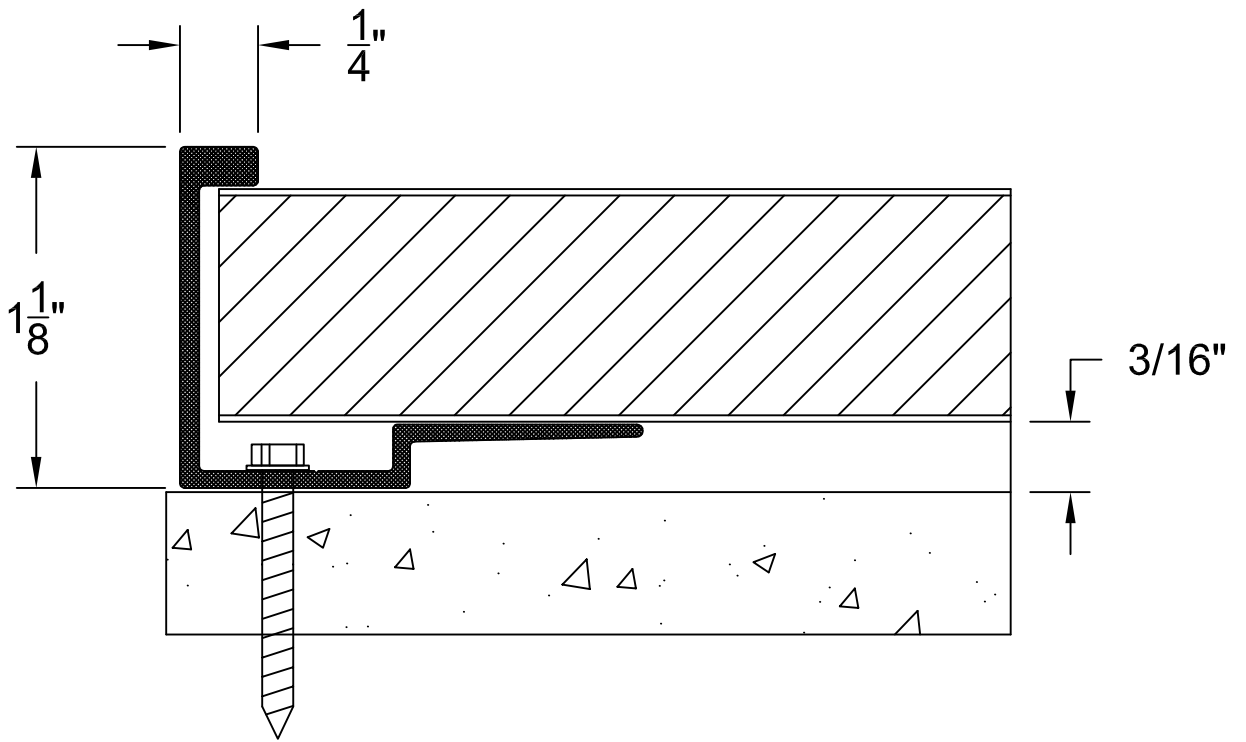

VERTICAL EDGE DETAIL - NL-770 EDGE TRIM

C