



INSTALLATION INSTRUCTIONS 1/4" – ARCHITECTURAL SYSTEMS TWO, THREE AND FOUR

HIGH-HUMIDITY AREAS: Many Surface System Panels are subject to the effects of moisture. DO NOT USE IN KITCHEN, REST ROOMS, OR OTHER HIGH-HUMIDITY AREAS.

TOOLS REQUIRED: Regular carpentry tools, such as a level, block plane, sanding block, drill, table saw or circular saw with fine-toothed carbide blade, chalk line, hack saw, tape measure, file, miter box, and square.

CAUTION: Be sure to use the proper safety guards required when cutting panels. Also wear safety glasses or face shields and hand protection.

NOTE - Metal veneer products may produce sparks when cutting. Take proper precautions for dust removal.

WALL PREPARATION: Structural walls should be finished with building completely closed. Walls must be thoroughly dry before panels are applied. Panels must be applied over a smooth, solid, flat backing such as plaster, drywall, or plywood. A vapor barrier should be used between backer and studs to discourage warping. Protect existing surfaces with drop cloths.

PREPARATION/HANDLING TIPS: Open cartons and carefully inspect all panels. Due to texture and manufacturing techniques, some panels may vary in color, consistency, and pattern. Panels must be stored in a dry environment. Store panels flat and off of concrete floors.

CONDITIONING: Panels should be allowed to equalize to the room environment prior to installation. This is accomplished by standing them around the room in which they are to be installed for at least 48 hours before application. Room temperature should be approximately 70° F.

FABRICATION: Always cut panels "face up" with a fine-toothed carbide-tipped table saw or "face down" with a portable power saw using a fine-toothed carbide-tipped blade to assure a clean-cut edge.

The use of a block plane, sanding block, or file will assist in minimal trimming and provide a clean edge. ALWAYS REFINISH AND SEAL TRIMMED EDGES.

Always use Surface System application hardware and perimeter trim designed for the job. They are easily cut with a hack saw or power miter box. Be sure to refinish all cut edges.

ADHESIVE REQUIRED: Marlite Brand C702 Heavy Duty adhesive is the adhesive recommended. This adhesive is a solvent based material and local code restrictions may require substitution. Any adhesive substitutions must have the manufacturer's approval. Clean tools with naphtha or mineral spirits. Read cautions on adhesive package before use.

CLEANUP: Surface System Panels are easily cleaned with a soft cloth using spray-on furniture cleaner/polish for coated surfaces and spray-on stainless steel cleaner/polish for all metal products. DO NOT SPRAY ANY LIQUIDS ON PANEL FACE OR SATURATE CLOTH WITH LIQUIDS.

Adhesive can be cleaned from the face of most Surface System panels with mineral spirits. ALWAYS TEST THINNERS ON A PIECE OF SCRAP MATERIAL.

Statements expressed in this technical bulletin are the recommendations for the application of Marlite brand products as outlined and illustrated under normal conditions of installation. The recommendations provided in the bulletin represent our best judgment based on our experience with normal applications. Unless prior approval is obtained in writing from Marlite, any deviation from these recommended procedures shall be at the sole risk of the installers. Carefully inspect all panels. If a panel is defective, notify the Marlite Service Center nearest you at once. Failure to do so shall be at the sole risk of the installer.

FASTENING HARDWARE/COPING TRIM

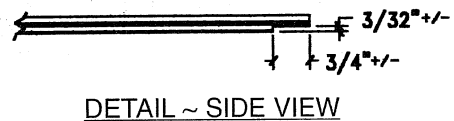
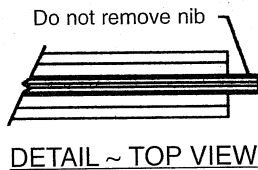
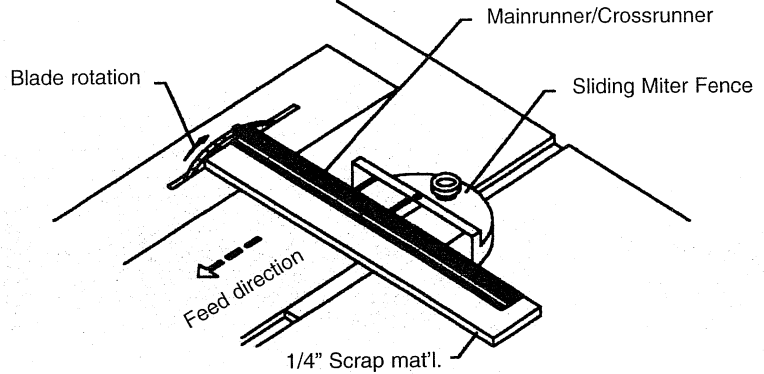
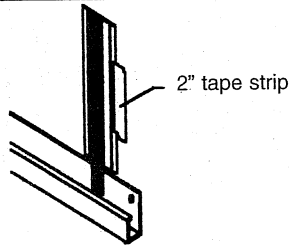
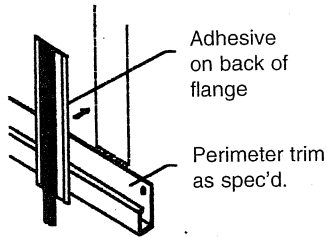

1 Removing Flanges From Mainrunners and Crossrunners

For fastest removal of flanges, use a table saw with a sliding miter fence and 60 to 80 tooth carbide blade. Set the sliding fence at 0° or square to the saw table. Use a scrap piece of 1/4" board under the runner flange; this will prevent the flange from sliding under the miter fence. Using a scrap of runner, adjust the blade height to remove the flange without cutting into the nibs on the sides of the runner profile (See details above). Once adjusted, proceed with removing flanges by starting at the end of the runner and making single passes through the blade until you remove a minimum of 3/4" of flange (See details above). This will allow proper installation of Mainrunners and Crossrunners at perimeter conditions. This applies to both Narrow and Channel runners.

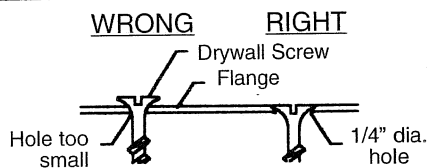

Drywall Screws
Drill through nailer groove on flange, taking care to center screw when attaching.

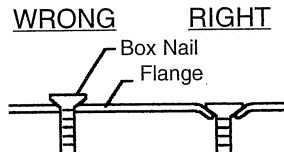

Nails
Fasten through nailer groove on flange.

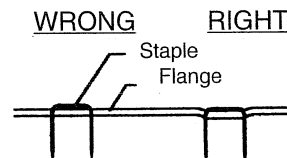

Staples
Fasten through nailer groove on flange.

2 Fastening Hardware/Trim

When attaching hardware and trim into wall studs or furring, it is important that any fasteners be flush into the trim flange. This will allow the panel modules to sit properly in the system. For this reason, any nails or screws must be countersunk into the Hardware/Trim flange (See above). When using drywall screws, a hole that is slightly smaller than the screw head is a fast and easy alternative to drilling and countersinking. A 1/4" diam. drill bit will work for most drywall screws. When attaching Hardware/Trim with adhesive, follow recommendations on the installation instructions.

3 Hardware Options

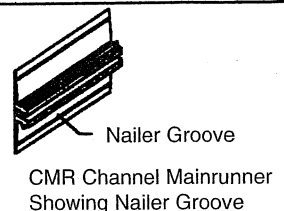
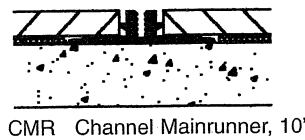
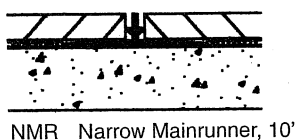

SURFACE SYSTEMS INSTALLATION INSTRUCTIONS

NOTE: This is a general detail page. Not all details apply to every installation.

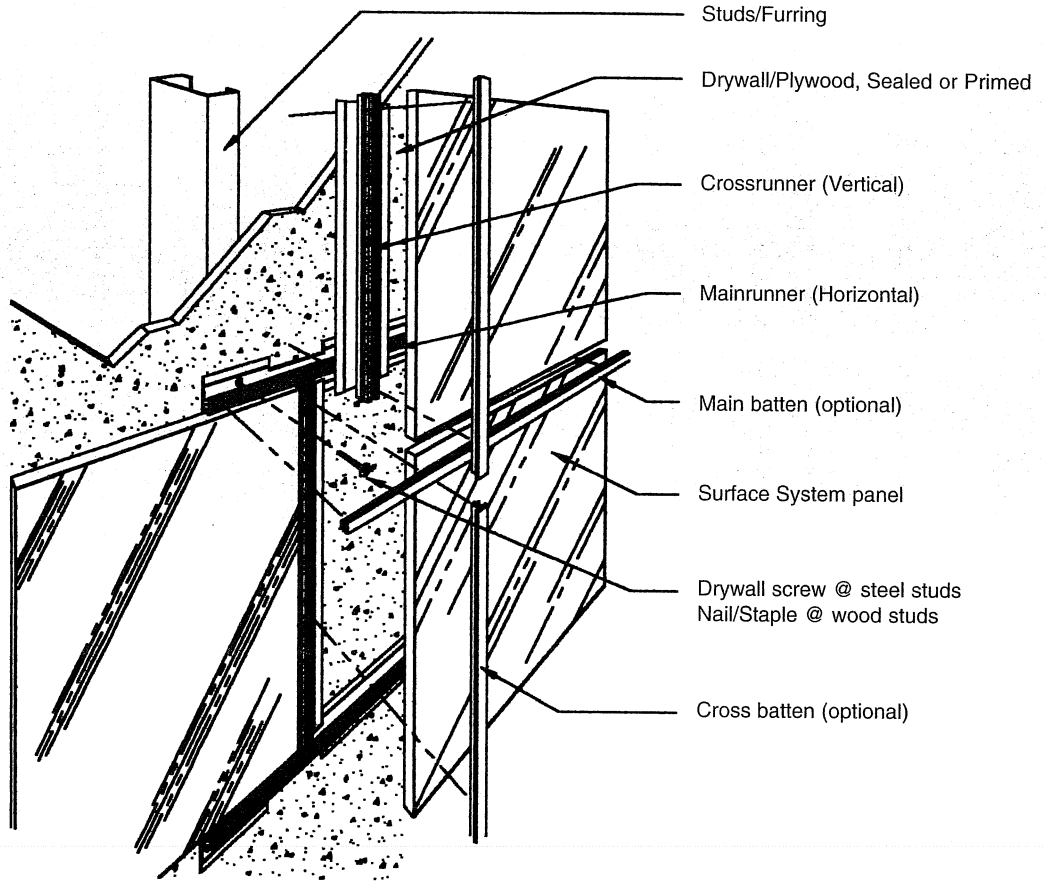

4 Typical System Installation

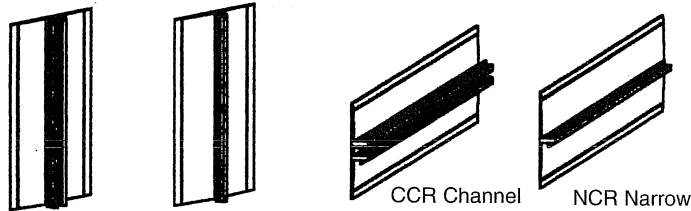

CCR Channel NCR Narrow
Vertical Crossrunners (16"/24")
See page 2 for additional details

CCR Channel NCR Narrow
Horizontal Mainrunners (120")
See page 2 for additional details

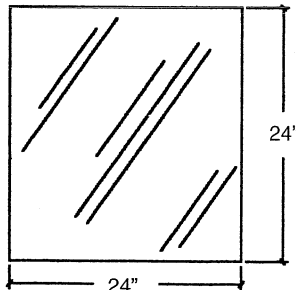
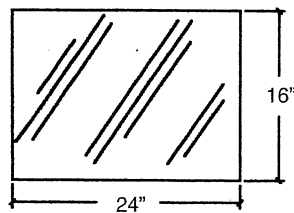

Many Surface Systems Panels are random in texture and color, this is intentional and to be expected. Care should be taken during installation to create a pleasing layout.

Surface Systems panels have a vertical grain direction unless otherwise specified by the architect or designer.

See page 6 of installation instructions for typical trim profiles. Finished panel sizes may vary with architect's specification.

5 Panels & Hardware

SURFACE SYSTEMS INSTALLATION INSTRUCTIONS

NOTE: This is a general detail page. Not all details apply to every installation.

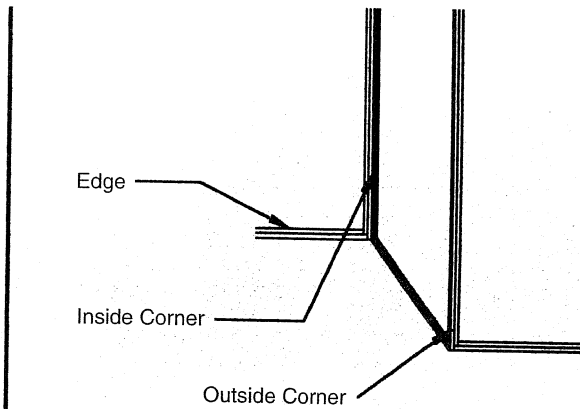
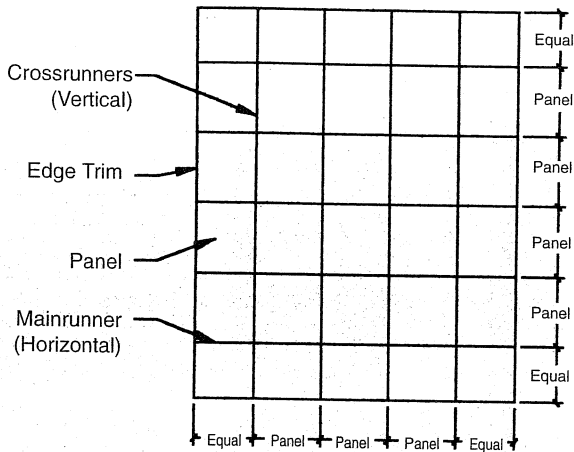

FOR ACTUAL TRIM PROFILES SEE PAGE 6

6 | Layout

See architectural elevation, or elevation provided, to determine layout and location of panels. To pre-plan a balanced layout, top & bottom panels should be equal in height and end panels should be equal in width (See illustration). Before installation begins it may be necessary to arrange panels on the floor to determine the best combination of color & pattern.

ALWAYS VERIFY ANY VARIATION IN PANEL LAYOUT, NOT INDICATED ON DRAWINGS, WITH ARCHITECT OR DESIGNER.

7 | Install Trim

Check plans for proper treatment of all perimeter conditions (ceilings, floors, corners, doors, windows, etc.). Install inside and outside corner trim first. Next, dry-fit edge trim by coping to fit profiles previously installed (miter-cut at intersections of edge trim). **DON NOT ALLOW TRIM FLANGES TO OVERLAP.** Secure all trim to subwall. When conditions do not allow screw or nail attachment of perimeter trim, apply a bead of adhesive to the back of the trim flange and press into place. Apply a light bead of adhesive to prevent squeeze-out and cleanup problems. Use 2" strips of masking tape at +24" C/C for the length of the flange to hold until the adhesive cures. This tape will not interfere with panel installation. **FOR COPING AND FASTENING HARDWARE SEE PAGE 2**

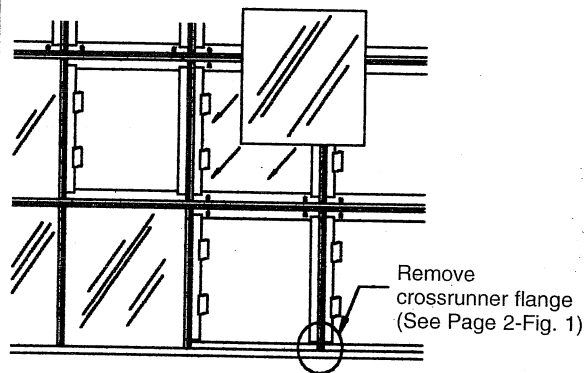
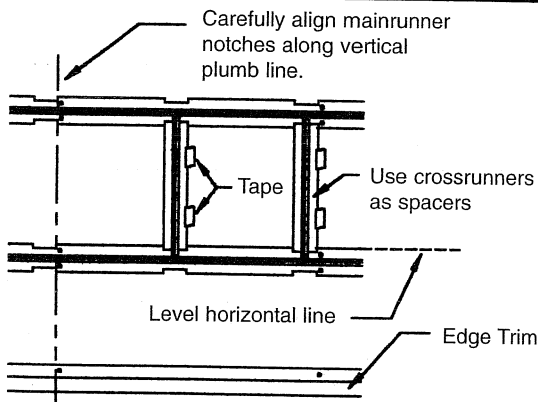

8 | Locate & Install Mainrunners

Locate centerline of first mainrunner. Measure up 3/4" to find top edge of mainrunner and mark a level horizontal line. Take care in locating this mainrunner so that the crossrunner notches will be properly located (See Layout, Step 6). Attach to wall @ max. 32" C/C (See Page 2-Fig. 2). Next, mark a vertical plumb line, using a notch on the first mainrunner, so mainrunners will be aligned vertically. This assures proper crossrunner alignment. Locate next and all mainrunners to follow using Surface Systems crossrunners as spacers. Where mainrunners intersect trim, remove mainrunner flange as required to clear trim flange (See Step 9).

9 | Install Crossrunners & Panels

Install all crossrunners by applying adhesive to back of flanges and fitting into mainrunner notches. Where trim occurs, remove crossrunner flange as required to clear trim flange (See Page 2-Fig. 1). **DO NOT INSTALL CROSSRUNNERS AND PANELS CLOSEST TO CORNER** (See Last 2 Panels, Step 8). Dry-fit panels before applying adhesive to verify fit. Correct fit should allow 1/32" clearance around panel perimeter. Trim as required. Always allow a minimum of 1/32" clearance for expansion in edge trim. Panels larger than 24" X 24" will require greater clearances. Apply adhesive to panels (See Applying Adhesive, Step 7) and install.

SURFACE SYSTEMS INSTALLATION INSTRUCTIONS

NOTE: This is a general detail page. Not all details apply to every installation.

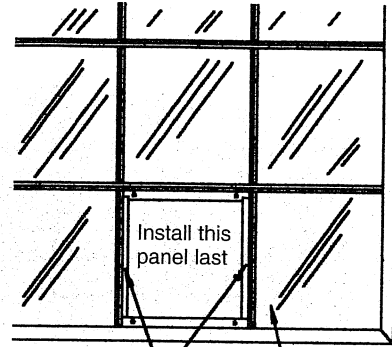
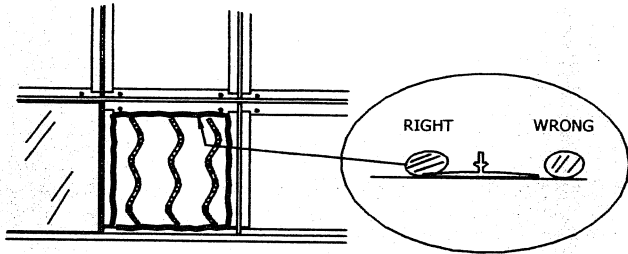

Install Crossrunners before last panel

Install corner panel before last panel

10 Applying Adhesive

Pre-fit panels and make necessary cutouts. Apply adhesive in a continuous bead around perimeter of hardware flange. Apply a bead of adhesive approximately 6" on center, the width between the vertical crossrunners as shown above.

Press and "knead" panels repeatedly to be certain of contact with the wall at all points. Fan the panel by pressing and pulling from the wall.

11 Install Last 2 Panels

Dry-fit last two panels and crossrunners to assure correct fit. Apply adhesive and install corner panel and crossrunners before the adjacent panel as indicated. Install last panel in normal fashion.

This step is not required with Shadowline Trim.

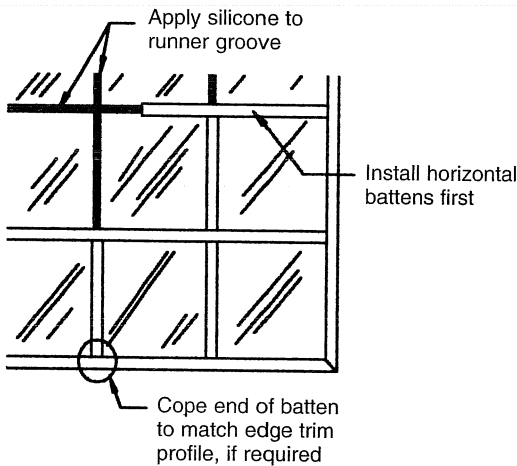

12 Install Battens (optional)

Install horizontal main battens first by applying clear silicone to groove in mainrunners. Allow silicone to air-cure for approximately 5 minutes before inserting the batten. Batten ends may have to be coped to fit profile of edge trim. Install vertical cross battens in the same manner as the horizontal main battens.

Use less silicone with "Shadowline" battens to avoid squeeze-out and clean-up problems.



Installation Details
Form No. SS 28-05 021



DOVER, OHIO 44622
(330) 343-6621
www.marlite.com

Copyright 2002

TRIM PROFILE

FLAT

SHADOWLINE

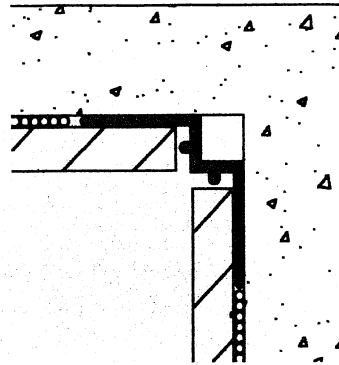
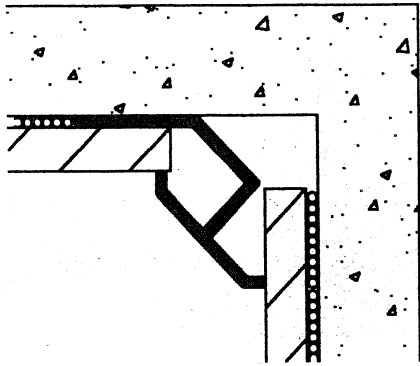

1 F-451 Flat Inside Corner

5 S-451 Shadow Inside Corner

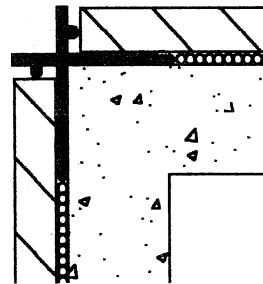
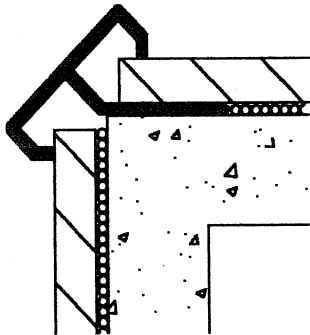

2 F-460 Flat Outside Corner

6 S-460 Shadow Outside Corner

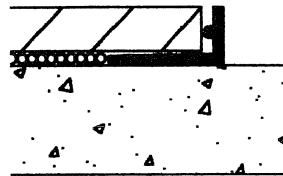
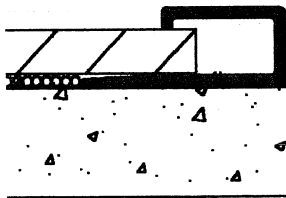

3 F-470 Flat Edge

7 S-470 Shadowline Edge

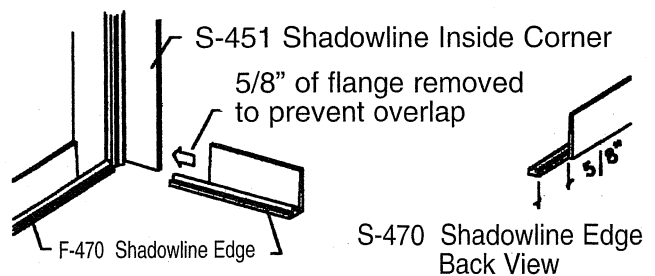
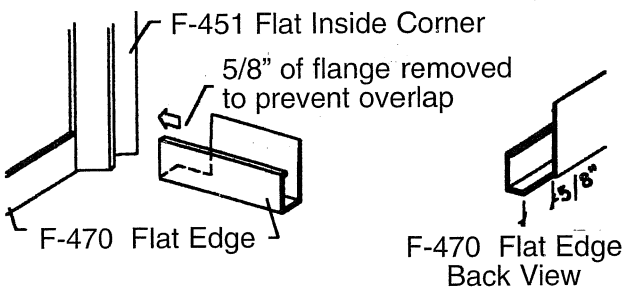

4 Coping Edge to Corner Trim

8 Coping Edge to Corner Trim