

# Myriad Systems

## Installation Instructions and Details

<b><u>Contents</u></b>	<b><u>Page</u></b>
General Notes	2
Typical System Perspective	3
Panel, Hardware & Trim Details	4-6
Hardware & Trim Fabrication Details	7-9
Installation Procedures	10-12
Installation with lights Procedures	13-15

For technical assistance, or if you have questions concerning your order, contact;

Marlite  
202 Harger St.  
Dover, Ohio 44622  
330-343-6621  
800-377-1221  
info@marlite.com  
www.marlite.com

Form # DC33-05081  
Effective Date: 7/07

# Myriad Systems General Notes

HIGH-HUMIDITY AREAS; Many Myriad Panels are subject to the effects of moisture. DO NOT USE IN KITCHEN, REST ROOM OR OTHER HIGH-HUMIDITY AREAS.

TOOLS REQUIRED; Regular carpentry tools, such as a level, block plane, sanding block, drill, table saw or circular saw with fine-toothed carbide blade, chalk line, hack saw, tape measure, file, miter box, square, 4'-6' or laser alignment tool and flat screwdrivers.

CAUTION; Be sure to use the proper safety guards required when cutting panels and trim. Also, wear safety glasses or face shields and hand protection.

NOTE - Metal veneer products may produce sparks when cutting.  
Take proper precautions for dust removal.

WALL PREPARATION; Structural walls should be finished with building completely closed. Walls must be thoroughly dry before panels are applied. Panels must be applied over a smooth, solid, flat backing such as plaster, drywall or plywood. A vapor barrier should be use between backer and studs to discourage warping. Protect existing surfaces with drop cloths.

PREPARATION/HANDLING TIPS; Open cartons and carefully inspect all panels. Due to texture and manufacturing techniques, some panels may vary in color, consistency and pattern. Panels must be stored in a dry environment. Store panels flat and off of concrete floors.

CONDITIONING; Panels should be allowed to equalize to the room environment prior to installation. This is accomplished by standing them around the room in which there are to be installed for at least 48 hours before application. Room temperature should be approximately 70° F.

FABRICATION; Always cut panels “face up” with a fine-toothed carbide-tipped table saw or “face down” with a portable power saw using a fine-toothed carbide-tipped blade to assure a clean-cut edge.

The use of a block plane, sanding block or file will assist in minimal trimming and provide a clean edge. ALWAYS REFINISH AND SEAL TRIMMED EDGES.

Always use Myriad System application hardware and perimeter trim designed for the job. They are easily cut with a hack saw or power miter box. Be sure to refinish all cut edges.

CLEANUP; Most Myriad System Panels are easily cleaned with a soft cloth using spray furniture polish for coated surfaces and spray-on stainless steel cleaner/polish for all metal products. For acrylic use recommended cleaner that is non-abrasive.

Statements expressed in this technical bulletin are the recommendations for the application of Marlite brand products as outlined and illustrated under normal conditions of installation. The recommendations provided in the bulletin represent our best judgment based on our experience with normal applications. Unless prior approval is obtained in writing from Marlite, any deviation from these recommended procedures shall be at the sole risk of the installers. Carefully inspect all panels. If a panel is defective, notify the Marlite Service Center nearest you at once. Failure to do so shall be at the sole risk of the installer.

# Exploded View of the Myriad Wall System

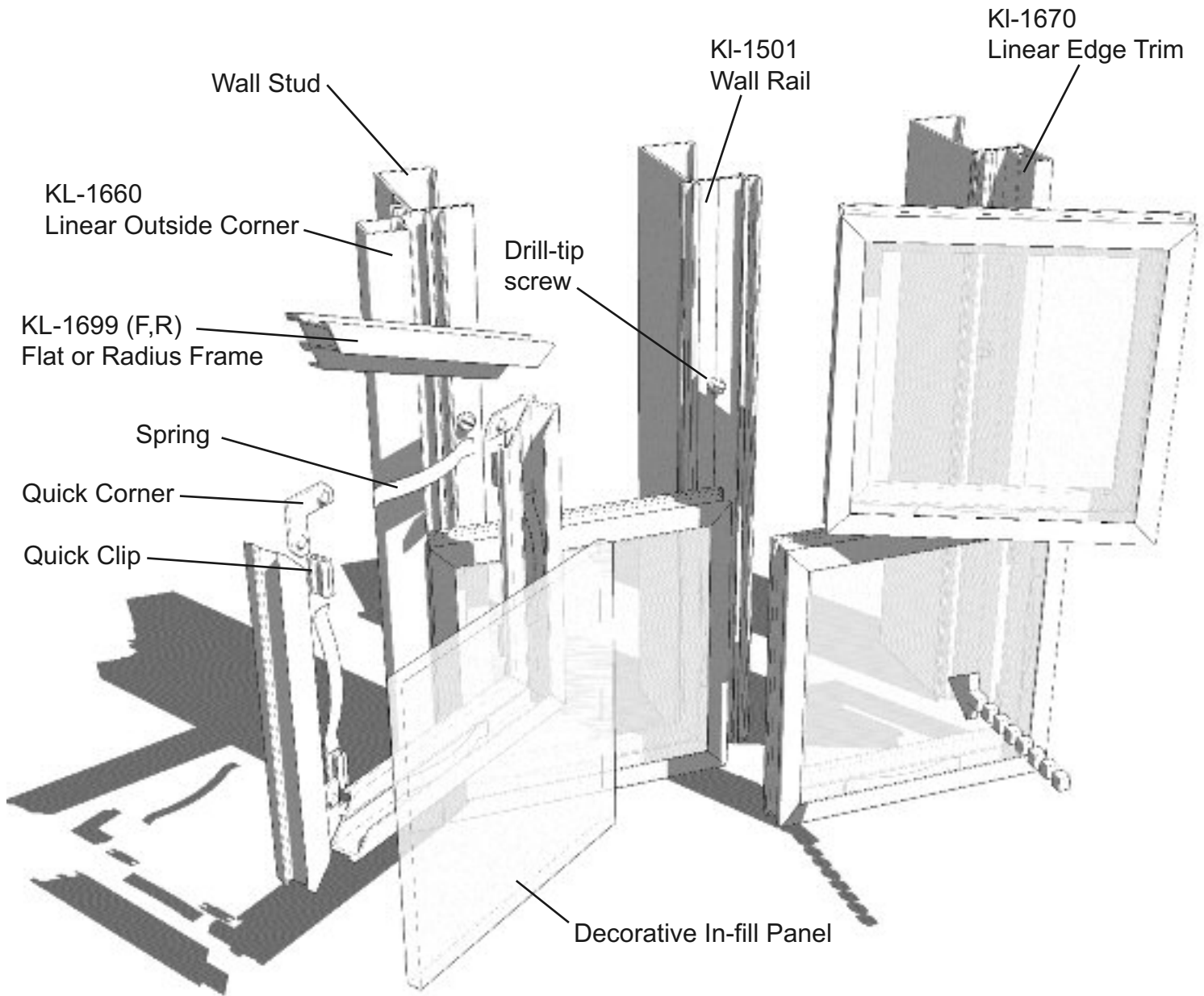

# MYRIAD WALL SYSTEM RADIUS FRAME DETAILS

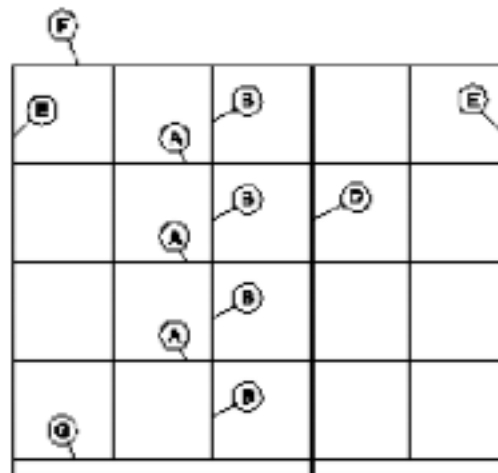
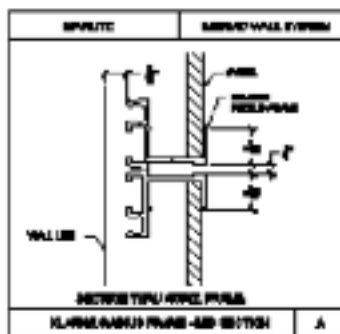

ELEVATION VIEW

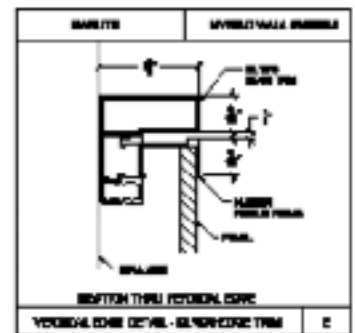
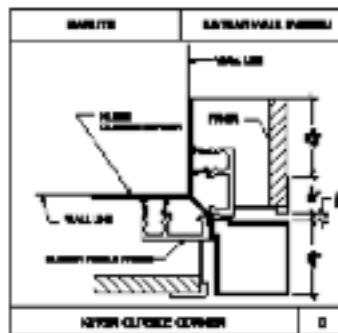
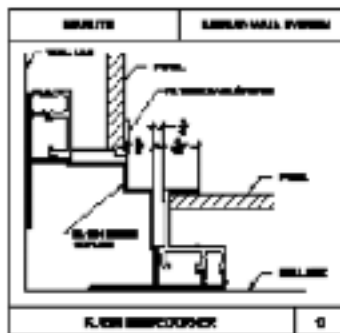
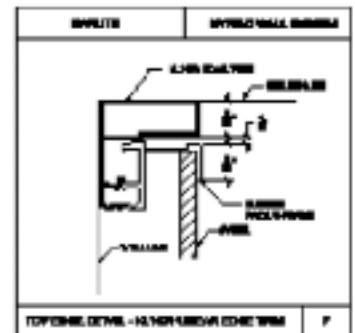
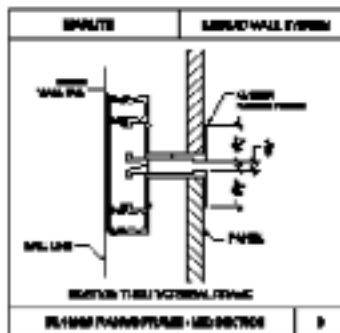
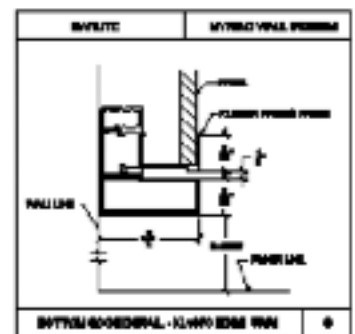



# Mitered Edge Notching Details

For use when Edge Trim is exposed.

**View from below.**

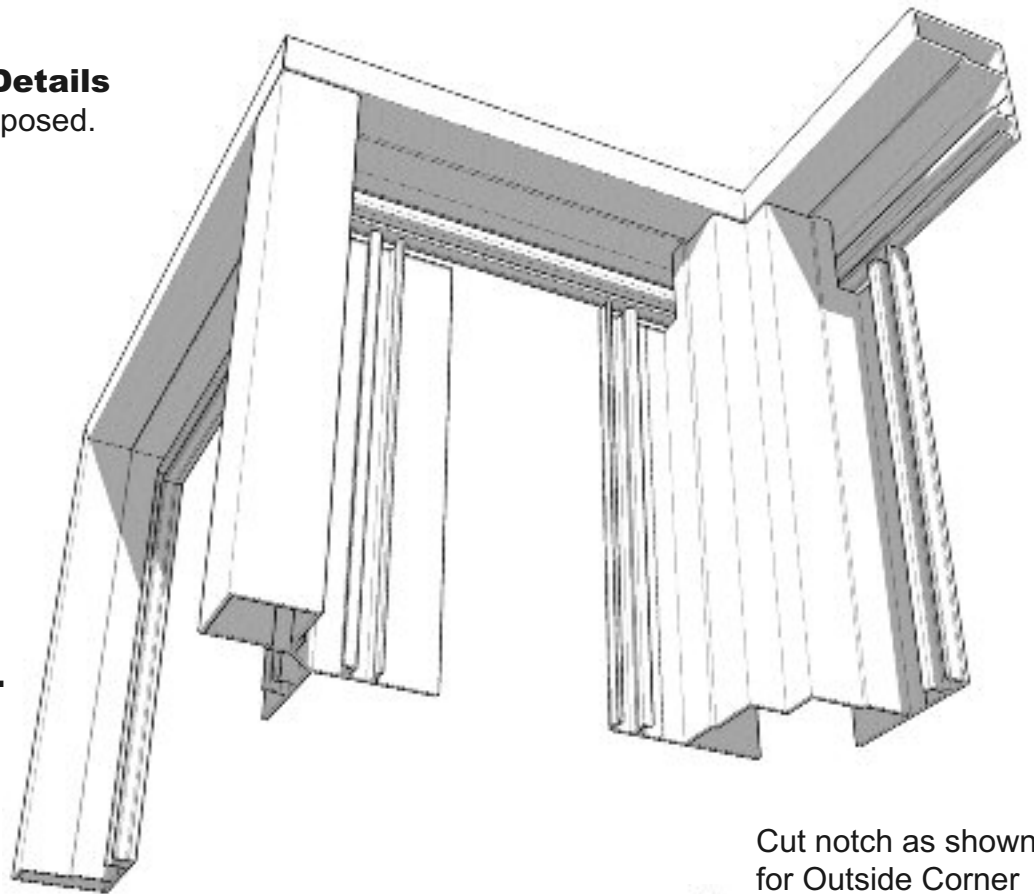

Cut notch as shown  
for Inside Corner

Cut notch as shown  
for Outside Corner

## Notching Details

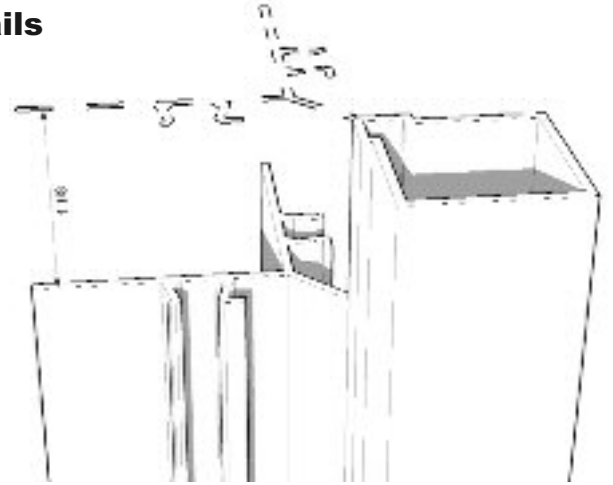
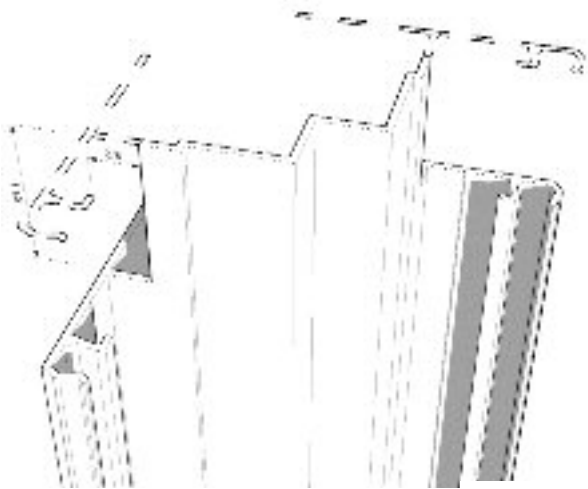

Mitered Edges

**View from above.**

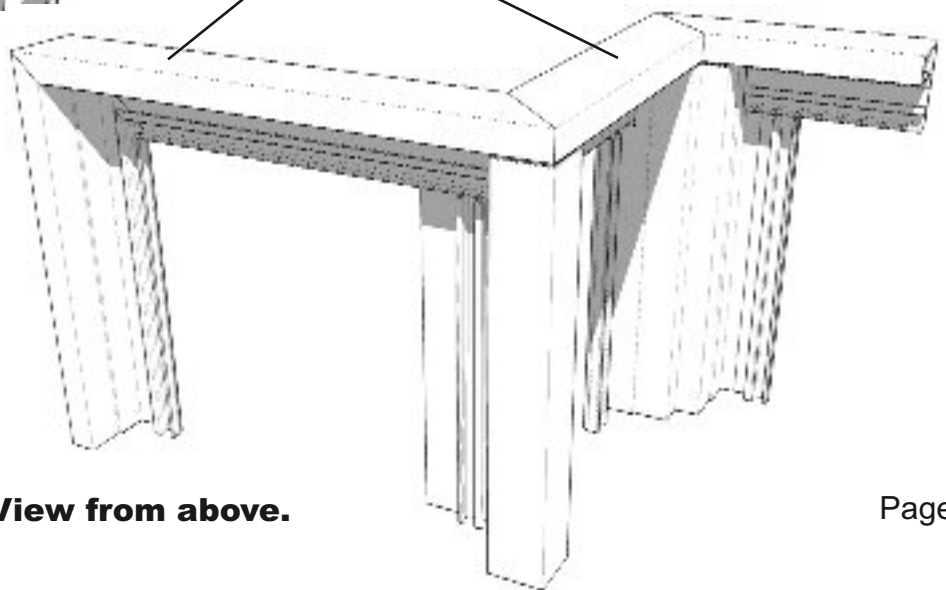

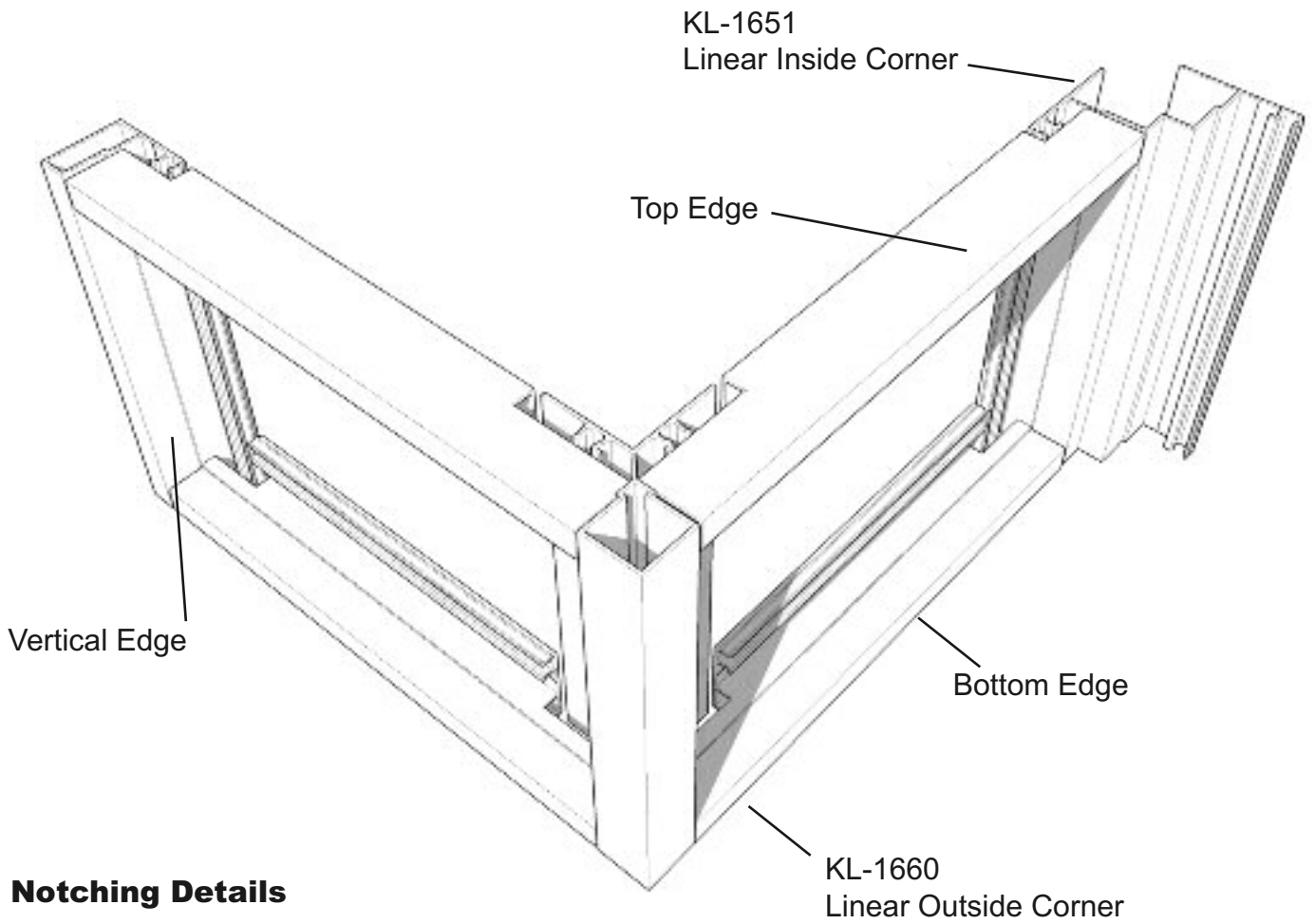

**Notching Details**

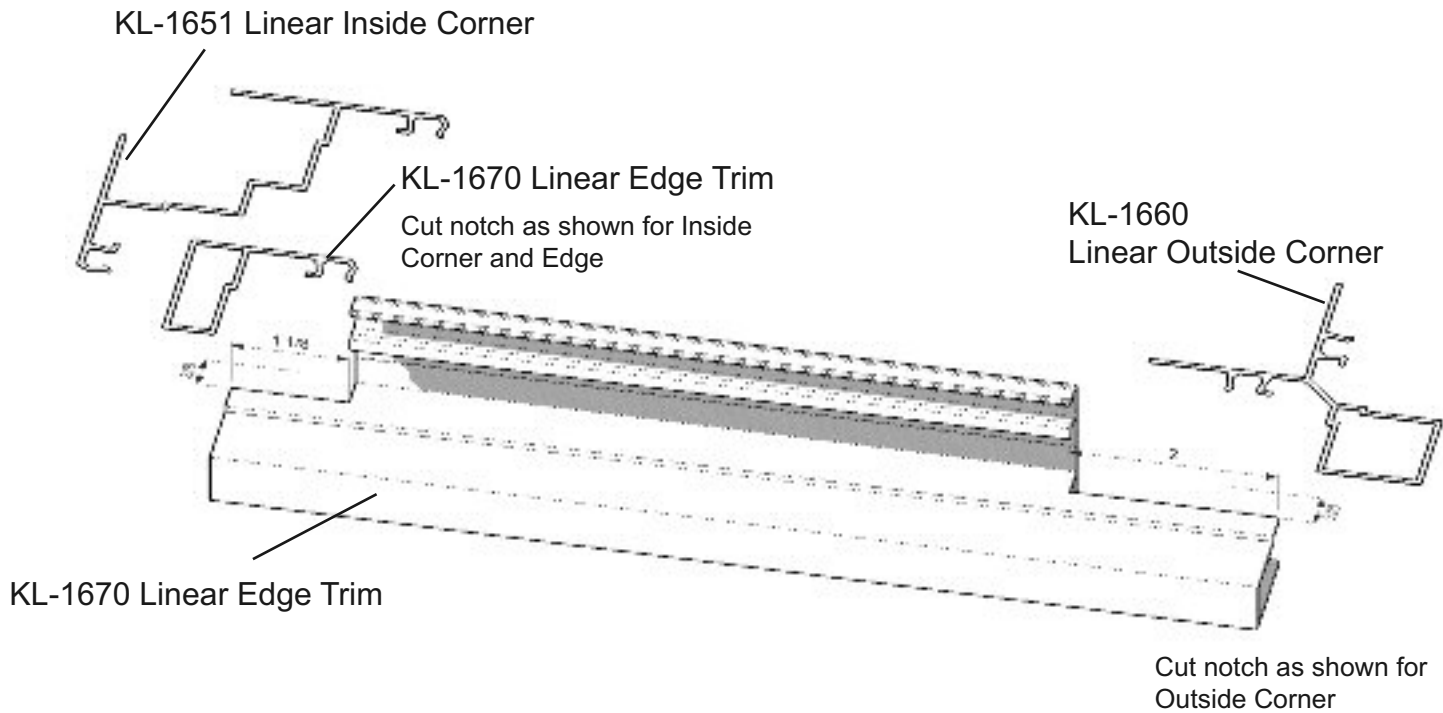

**Non-Mitered Edge Notching Details**  
For use when the top and/or bottom Edge Trim is tight to other surfaces.

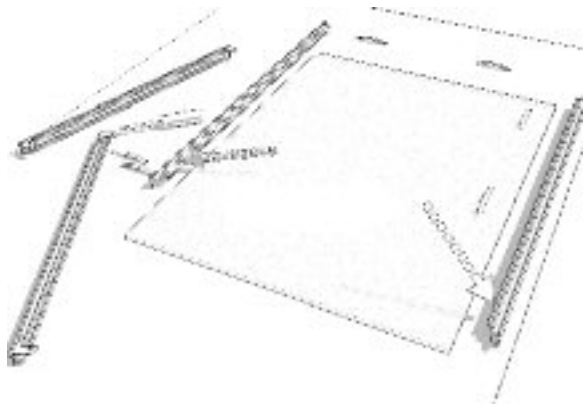

Disassemble the panel as shown, to prepare for mitering the panel frame and cutting the in-fill panel.

Using a sharp carbide-tipped blade, re-miter the frame as necessary.

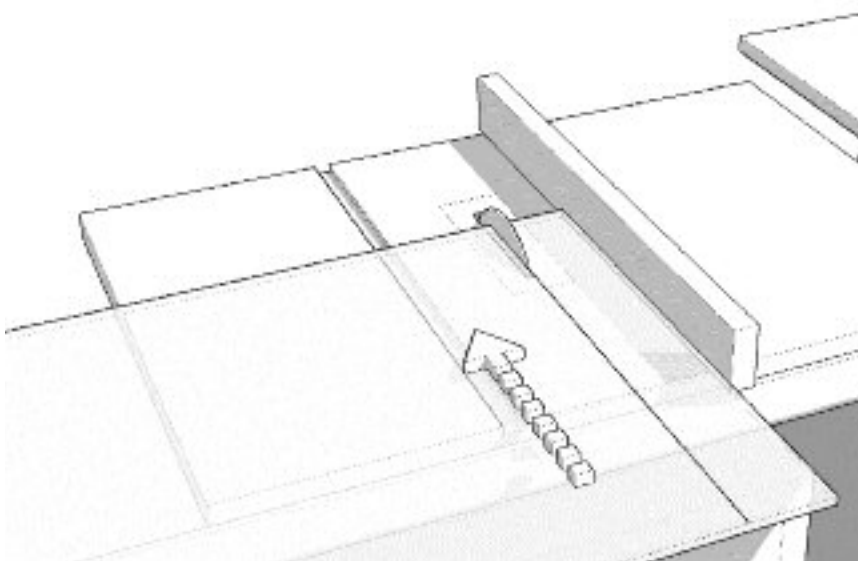
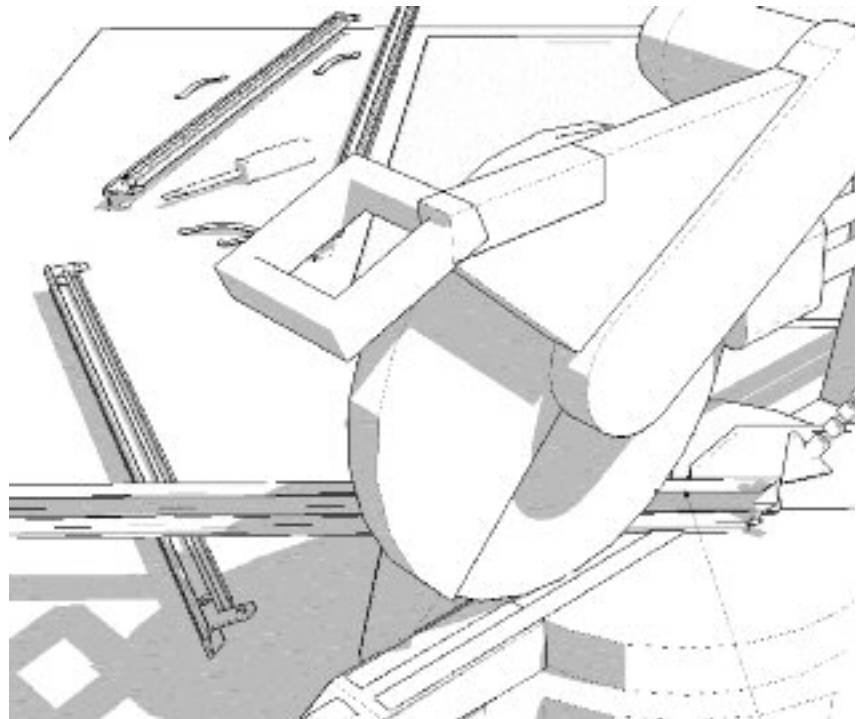

Use the appropriate method to cut the in-fill panel to size. The in-fill panel will be 1/2" smaller than the frame's outside out/out size.

Re-assemble the panel for installation.

## Quick Clip installation/removal details.

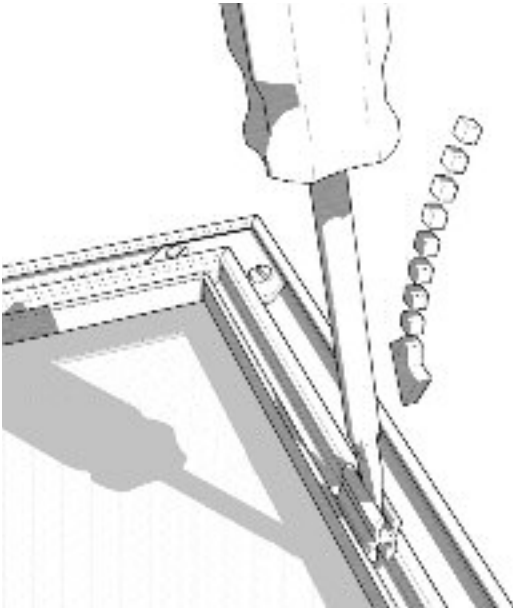

Install using a flat blade screwdriver or stiff putty knife and pushing the Clip into the groove. It helps to start at an angle and pivot the part while applying pressure.-

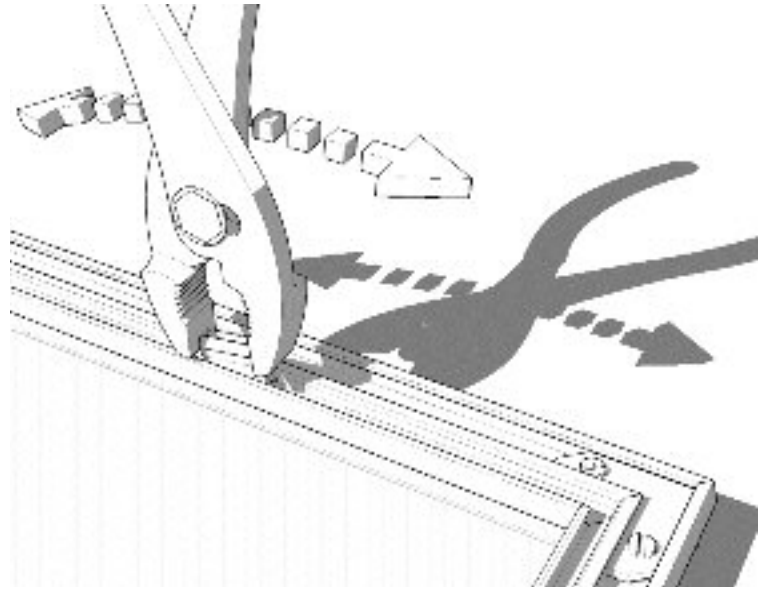

Remove by grasping with pliers and pivoting, while pulling up on the clip.

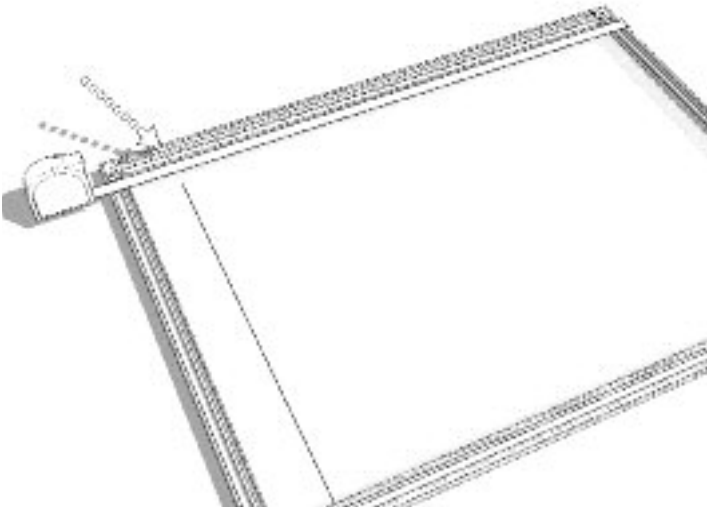

Measure and mark the panel and frame as required for cutting to fit wall conditions.  
The in-fill panel will be cut to 1/2" smaller than the out/out size of the panel frame.

Measure the out/out dimension from the widest edge, near the back of the panel.

Do not measure from this front edge.

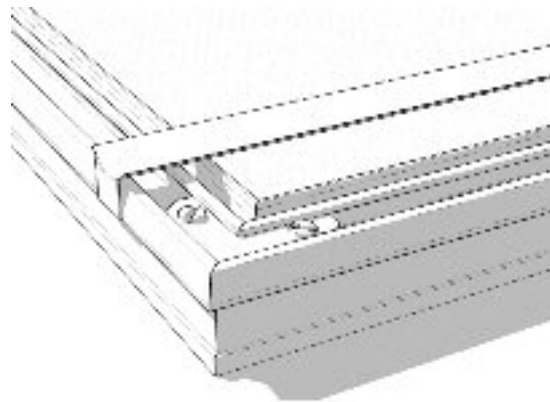

## Panel Field Fabrication Details

Use an appropriate flat-blade screwdriver to loosen Quick Corner brackets as required for disassembly.

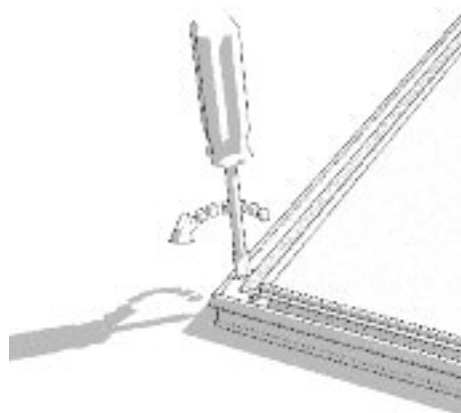

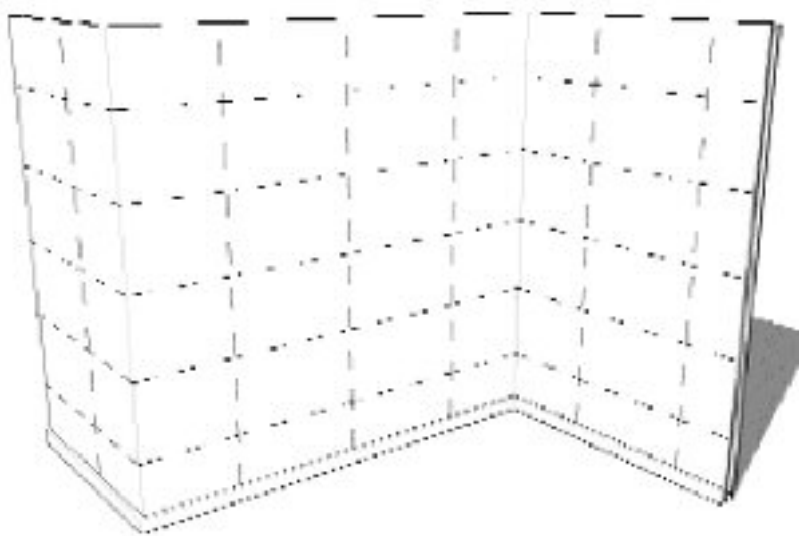

**Note: Accuracy and precision in measurements and installation are critical to a successful Myriad project.**

### Step 2

Before installing trim you'll need to determine the edge conditions and decide to use either **Mitered Edge Notching** or the **Non-Mitered Edge Notching**, as described on pages 4 & 6.

For these instructions we'll use the Non-Mitered Edge method.

Begin by installing all vertical trim with drill-tipped screws that are long enough to engage the wall framing.

**It is very important to plumb these parts as precisely as possible.**

Use a laser or long bubble level and shim as necessary behind the screws that keep the parts straight.

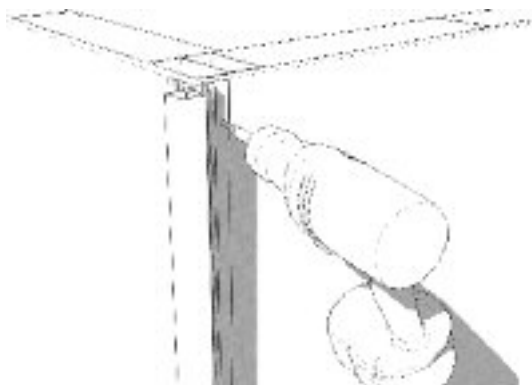

### Step 1

See architectural elevation to determine layout and location of panels. To pre-plan a balanced layout, top & bottom panels should be equal in height and end panels should be equal in width (See Illustration). Before installation begins it may be necessary to arrange panels on the floor to determine the best combination of color & pattern.

ALWAYS VERIFY ANY VARIATION IN PANEL LAYOUT, NOT INDICATED ON DRAWINGS, WITH ARCHITECT OR DESIGNER.

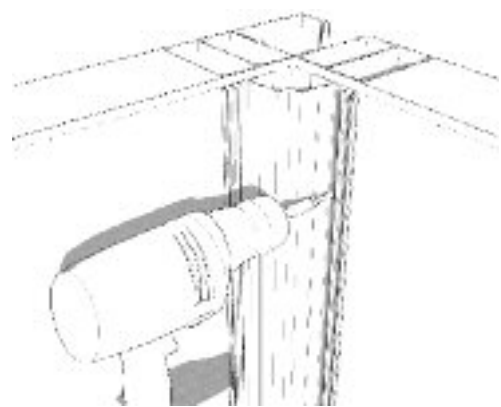
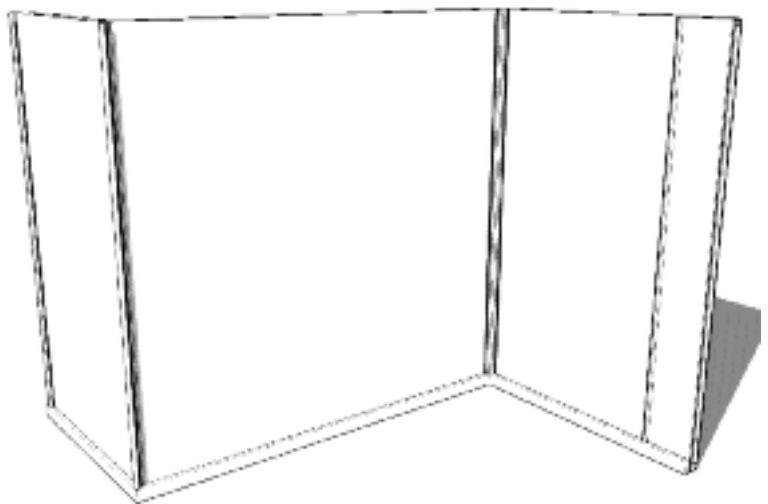

**Detail of vertical trim attachments.**

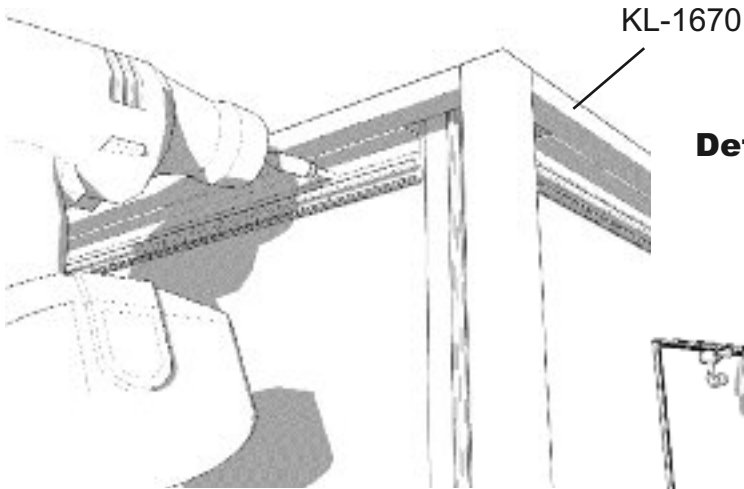

**Detail of horizontal trim attachment.**

**Step 3**

Install Edge Trim along top and bottom.

**It is very important that the top and bottom edge be leveled as precisely as possible and that the vertical distance between them doesn't change.**

Use a laser or a long bubble level and shim as necessary to keep the Edge Trim straight.

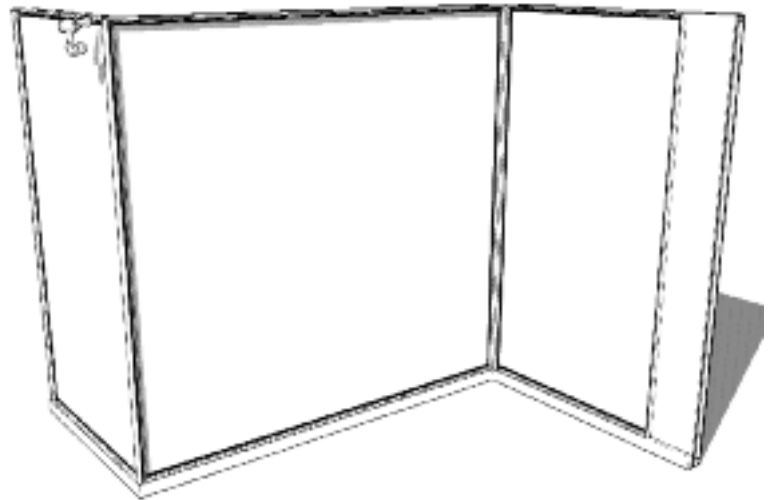

**Step 4**

Using the designer's layout, measure the height of the first row of panels and cut to size, according to pages 4 & 5 of these instructions.

**Step 5**

Insert the attachment clips into the back of the panels according to the details on page 6 at 6-8" on center, max. to prepare them for installation.

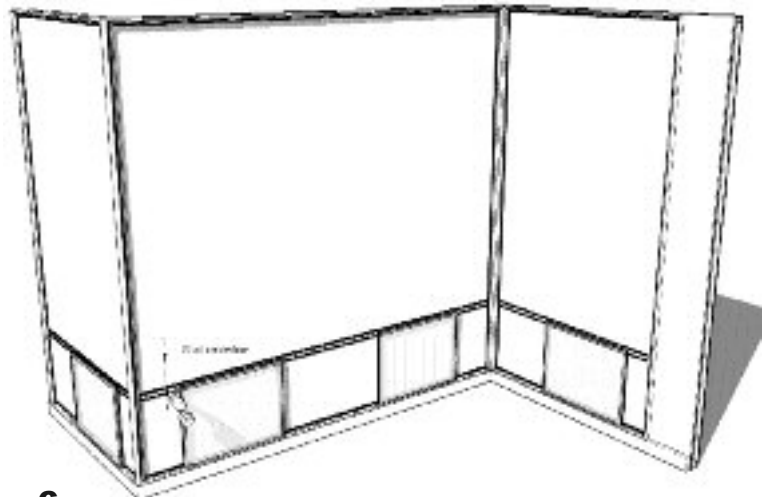

**Step 6**

Using panels with the clips already installed, attach two panels onto the bottom Edge Trim, as shown. The panels will act as spacers for the Wall Rail. Snapping the Wall Rail onto the top edge of the panel will give the precise spacing required. Simply attach the Wall Rail with 2 or 3 drill-tipped screws, remove the panels and finish installing screws into all the studs.

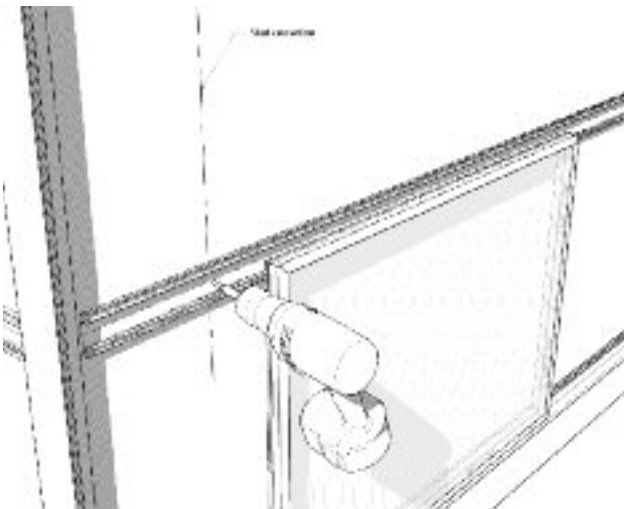

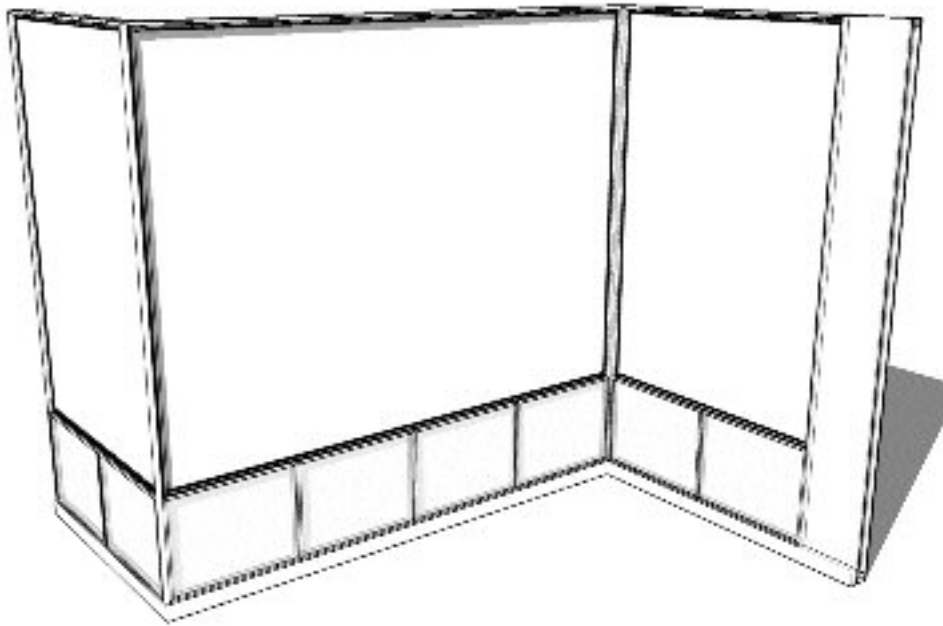

**Step 7**

Install the first row of panels by snapping them firmly into place. Be sure they are fully seated and all panels are flush to each other.

**Step 8**

Repeat previous steps as necessary to complete the installation.

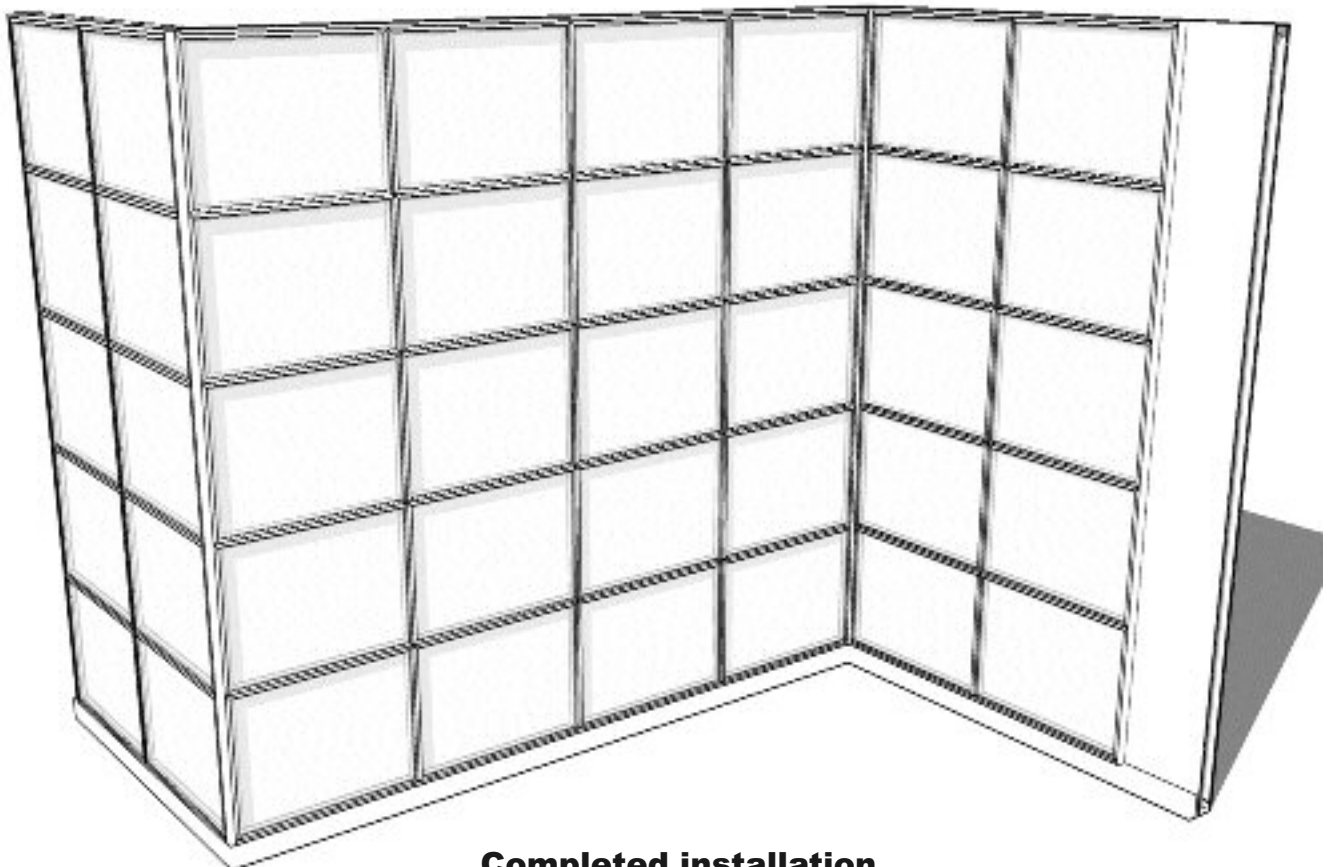

**Completed installation.**

## Installation with lights.

### Step 1

See architectural elevations to determine panel layout and location. Stud spacing will be dependent on panel width. Stud spacing must match the panel center-to-center dimensions. Details for the construction of a cove to accommodate light sources are the responsibility of the project designer. Lighting specification is the responsibility of the project designer.

**Note: Accuracy and precision in measurements and installation are critical to a successful Myriad project.**

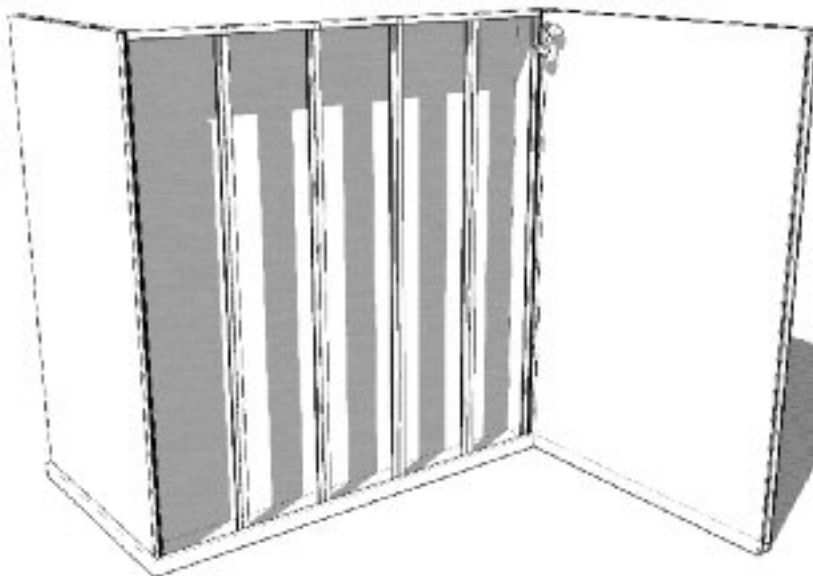
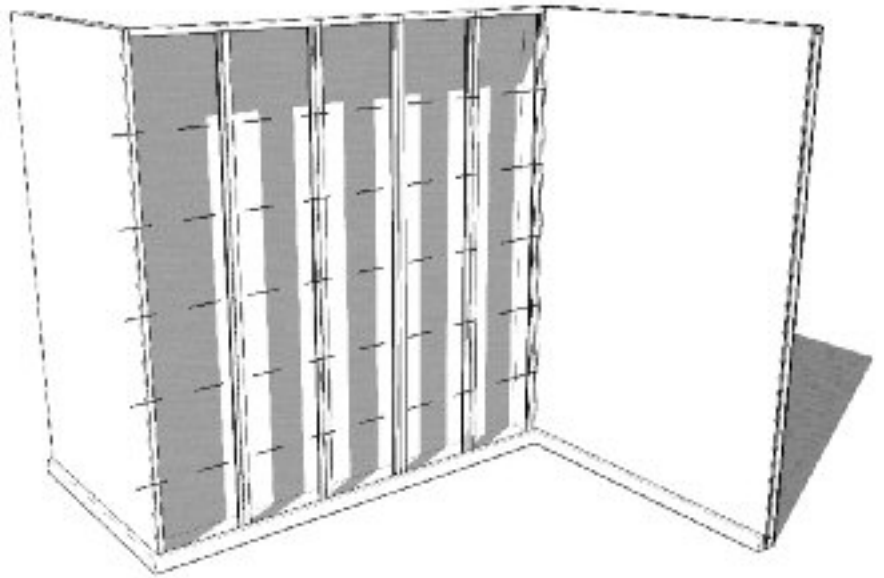

### Step 2

Before installing trim you'll need to determine the edge conditions and decide to use either **Mitered Edge Notching** or the **Non-Mitered Edge Notching**, as described on pages 4 & 5. For these instructions we'll use the Non-Mitered Edge method.

Begin by installing all vertical trim with drill-tipped screws that are long enough to engage the wall framing. **It is very important to plumb these parts as precisely as possible.** Use a laser or long bubble level and shim as necessary behind the screws to keep the parts straight.

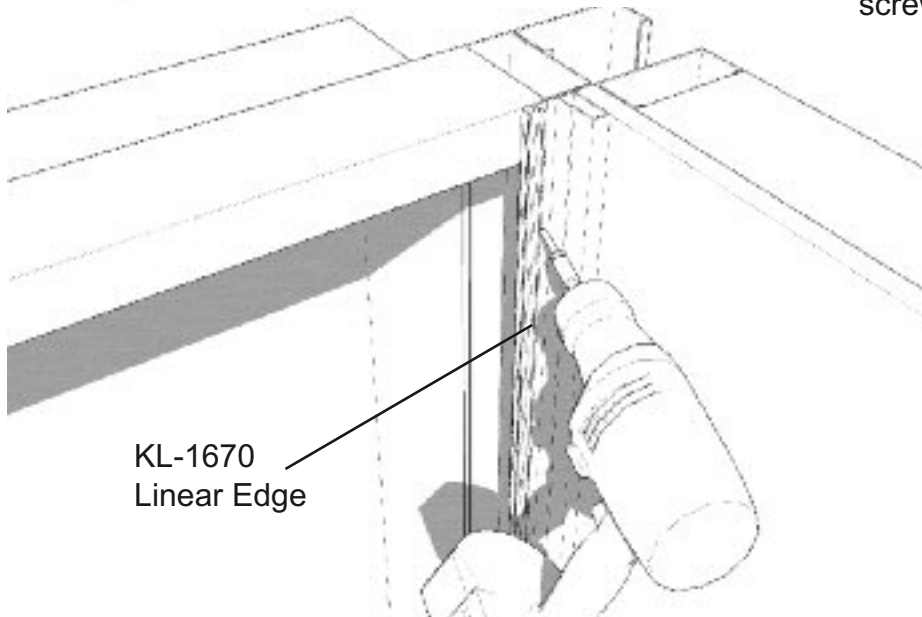

KL-1670  
Linear Edge

**Detail of vertical trim attachments.**

## Detail of horizontal trim attachment.

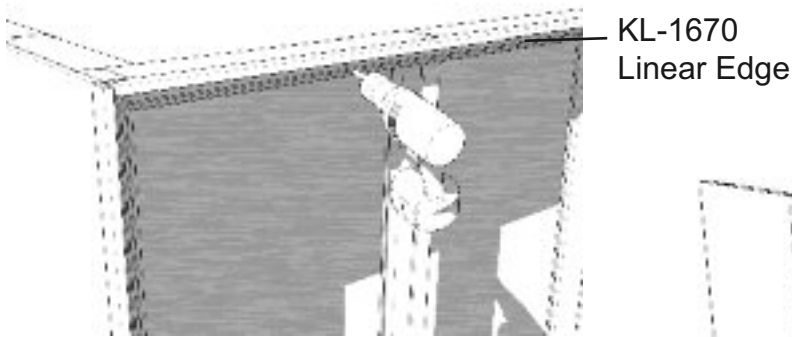

### Step 3

Install Edge Trim along top and bottom.

**It is very important that the top and bottom edge be leveled as precisely as possible and that the vertical distance between them doesn't change.**

Use a laser or a long bubble level and shim as necessary to keep the Edge Trim straight.

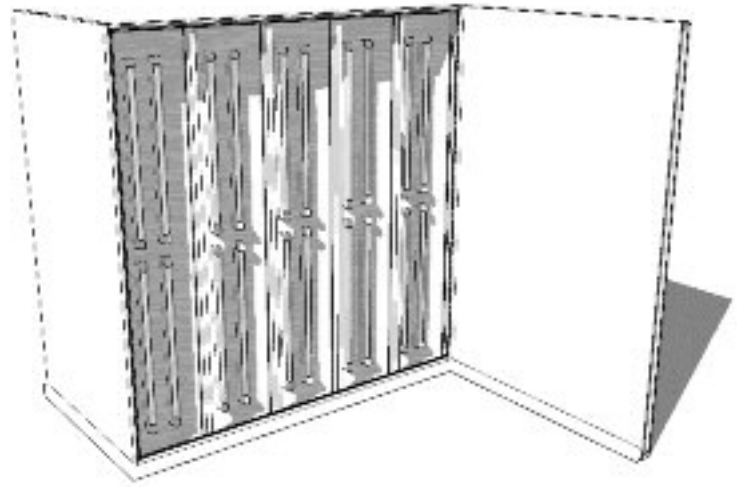

### Step 4

Using the designer's layout, measure the width of the first row of panels and cut to size, according to pages 6 & 7 of these instructions.

### Step 5

Insert the attachment clips into the back of the panels according to the details on page 6 & 7 6-8" on center, maximum to prepare them for installation.

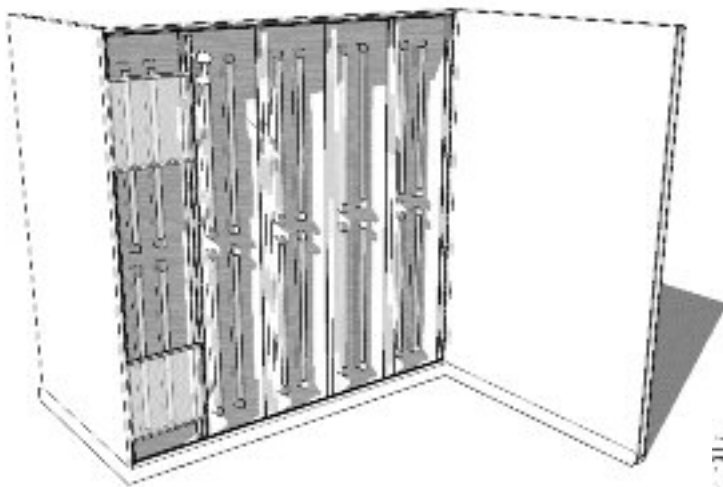

### Step 6

Using panels with the clips already installed, attach two panels onto the vertical Edge Trim, as shown. The panels will act as spacers for the Wall Rail.

Snapping the Wall Rail onto the opposite edge of the panel will give the precise spacing required. Simply attach the Wall Rail with 2 or 3 drill-tipped screws, remove the panels and finish attaching at approximately 8" c/c.

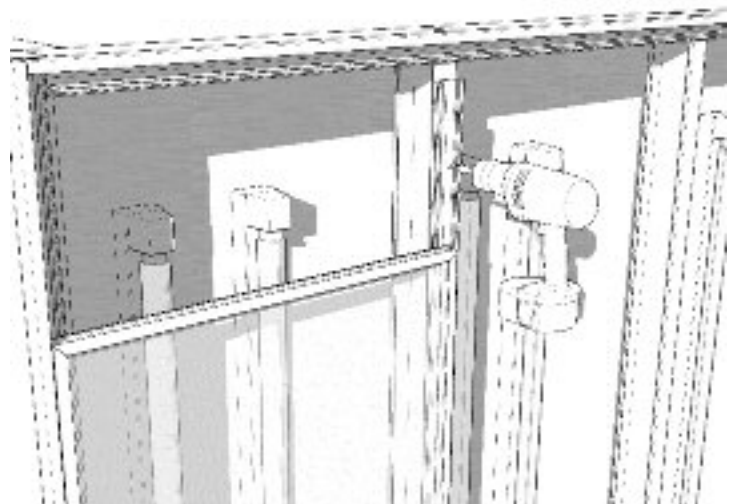

## Detail of Wall Rail attachment.

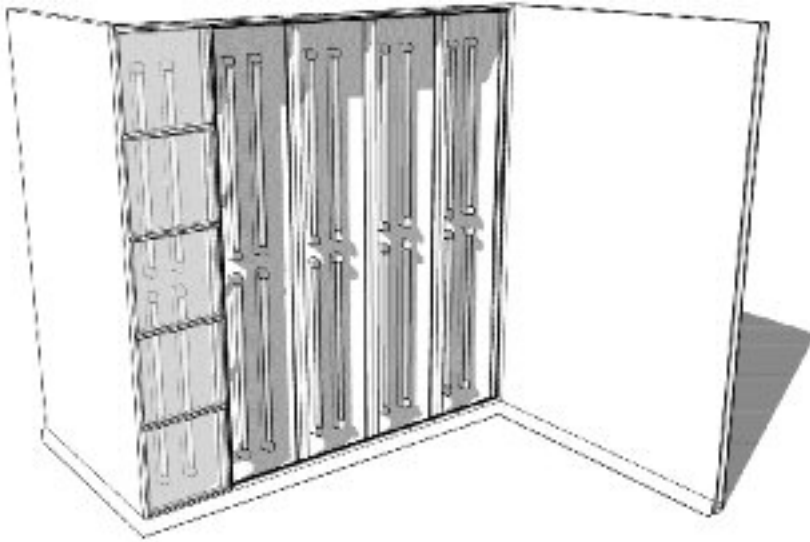

**Step 7**

Install the first row of panels by snapping them firmly into place. Be sure they are fully seated and all panels are flush to each other.

**Step 8**

Repeat previous steps as necessary to complete the installation.

